

4

3

2

1

Ø 2.38 OD
Ø 2.06 ID
Tenon
(4 Places)

Ø 1.50
Hole
(2 Places)

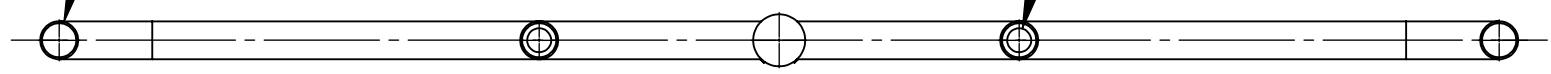

B

B

30.00 30.00 30.00

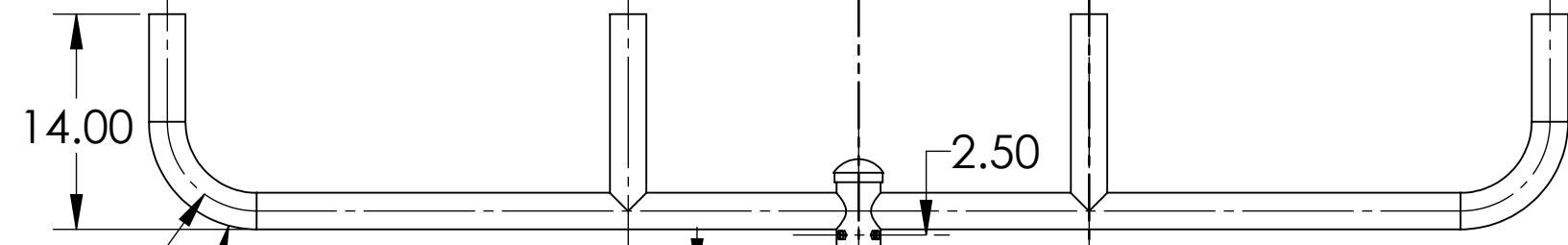

14.00
R5.81 REF
R7.00

1.00

2.50
Ø 2.88 OD
Ø 2.50 ID

Hex Head Screw
Black Oxide
3/16-18 x 1.00 Long
4 Places

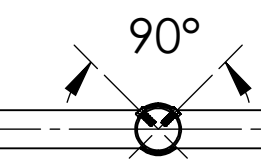

90°

Ø 2.38 OD
Ø 2.06 ID

A

A

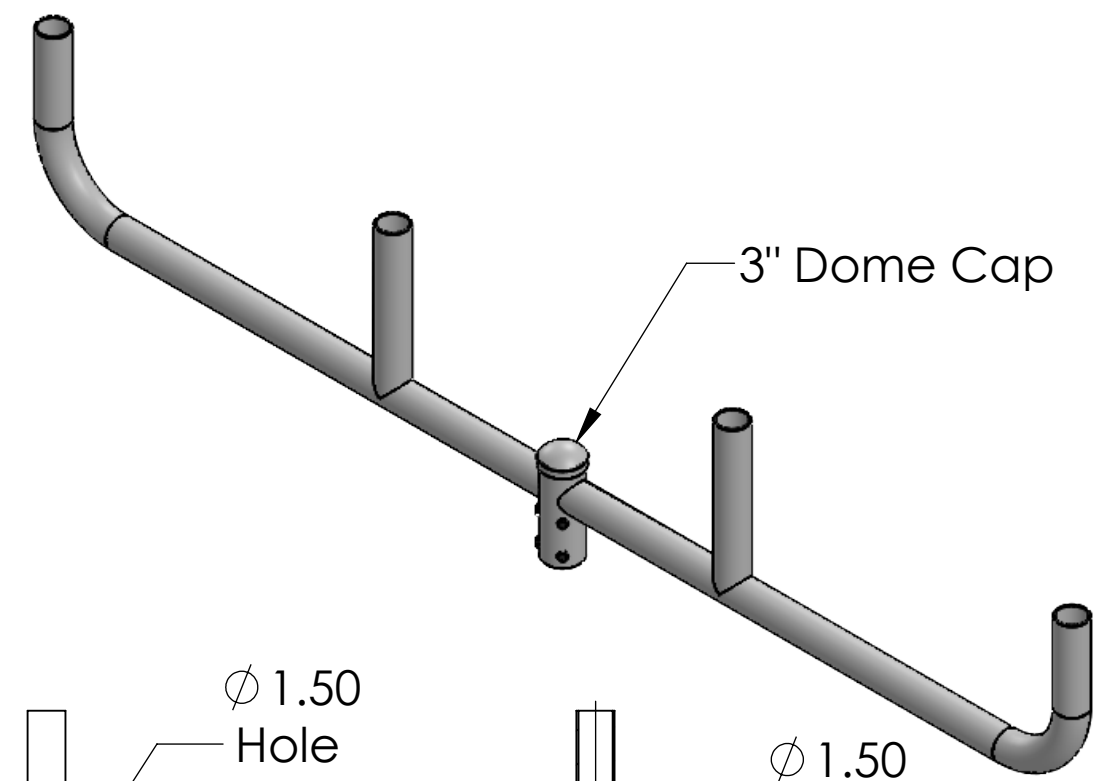

3" Dome Cap

Ø 1.50
Hole
(2 Places)

Ø 1.50
Hole
(2 Places)

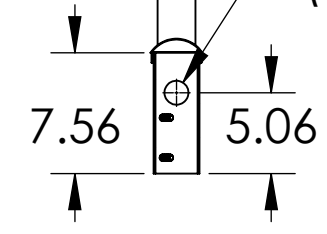

SECTION A-A

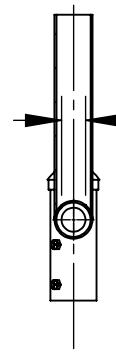

SECTION B-B

All dimensions and specifications are subject to change without any notice.

PROPRIETARY AND CONFIDENTIAL
THE INFORMATION CONTAINED IN THIS DRAWING IS THE SOLE PROPERTY OF Energy Light, Inc. ANY REPRODUCTION IN PART OR AS A WHOLE WITHOUT THE WRITTEN PERMISSION OF Energy Light, Inc. IS PROHIBITED.

| | | | | | | | | |
|-------------|---------|--|--|--|------|-------------|--|--------------|
| | | UNLESS OTHERWISE SPECIFIED: | | NAME | DATE | TITLE: | | |
| | | DIMENSIONS ARE IN INCHES TOLERANCES: FRACTIONAL ± 1/64 ANGULAR: ± 0.5° TWO PLACE DECIMAL ±0.01 THREE PLACE DECIMAL ±0.005 | | DRAWN | MKA | 10-22-20 | Bullhorn with 4 Arms Inline | |
| | | INTERPRET GEOMETRIC TOLERANCING PER: | | ENG APPR. | | | | |
| | | MATERIAL | | MFG APPR. | | | | |
| NEXT ASSY | USED ON | FINISH | |  Energy Light, Inc. 1881 Rose Road Lake Zurich, IL 60047 | | SIZE | ITEM NO. | REV |
| APPLICATION | | DO NOT SCALE DRAWING | | | | B | 10062 | |
| | | | | | | SCALE: 1:12 | WEIGHT: 41 lbs | SHEET 1 OF 1 |

4

3

2

1