

547119

35 Foot Square Steel Light Pole,
6 Inch Wide, 7 Gauge



Job: _____
 Job Site: _____ State: _____ Client Name: _____
 Notes: _____ Approvals: _____ Date: _____

Pole Top Options: A removable pole cap is provided if the pole is drilled for attaching light fixtures. The drill pattern and drill orientation needs to be provided by the customer unless Energy Light fixtures are used for the project. If tenon option is selected, a steel tenon will be provided. A 2 3/8 inch diameter tenon with 4 inch length is standard; however, the customer needs to confirm the appropriate tenon size required for the project.

Pole Shaft: 6 inch square 7 gauge commercial grade steel with minimum yield strength of 50,000 psi. Pole height is 35 ft.

Handhole: 3" X 5" size reinforced handhole is located at 18 inches from the base. A ground lug with set screw is located near the handhole opening for proper grounding of the pole.

Color: Commercial grade, super durable powder coat is the standard option.

Dark Bronze, White, Black and Gray colors are provided at no extra charge. Other colors and custom colors options are available at a surcharge. Hot dip galvanizing is available with a surcharge and extended lead time. Powder coated, galvanized poles are also available as a premium option.

Anchor Bolts: A set of 4 galvanized steel anchor bolts is provided with each pole assembly. Each anchor bolt includes 2 nuts and 2 washers. Top portion of the anchor bolt is threaded for securing and leveling the pole with the provided nuts and washers. An actual size paper anchor bolt template is provided.

Bolt Circle: 12" (Bolt Circle Range 11"-13")

Base Cover: Two-piece steel square base cover. Stainless steel screws are included to attach the 2 pieces together after pole installation.

Other Options: The following options are available at an extra charge:

Vibration dampener, custom tenon sizes, custom colors, electric/GFI outlets, custom pole heights, additional handholes, UL compliant handholes and custom base plate dimensions.

Warranty: 1 Year.

Foundation design: Foundation should be designed by an engineer familiar with local soil and wind conditions as well as local code where the pole(s) will be installed.

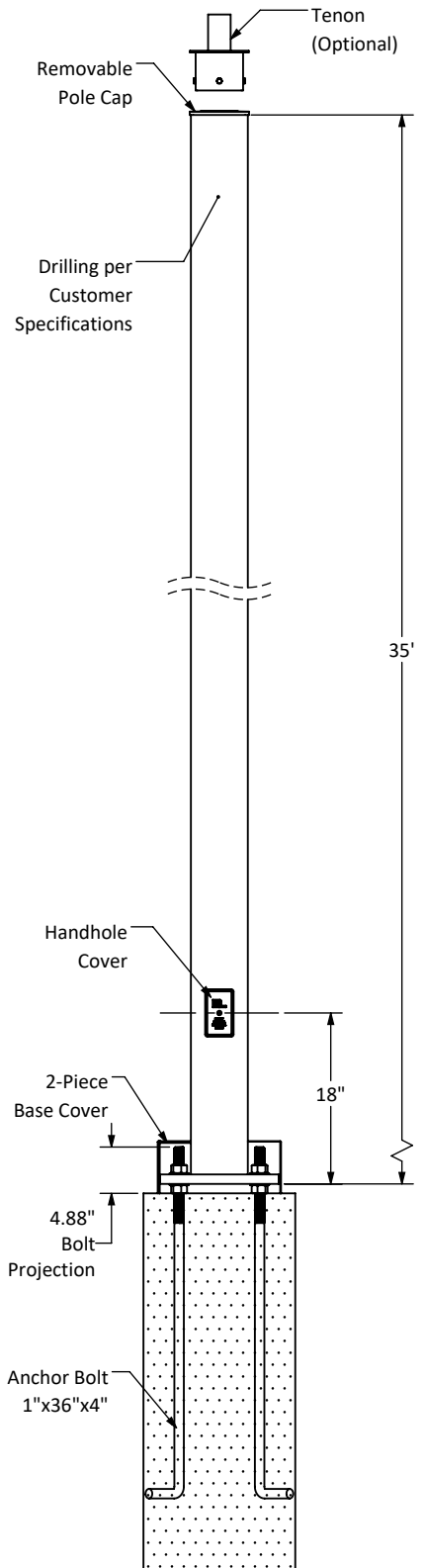

Maximum EPA with 1.3 Gust Factor (ft ²) per AASHTO LRFDLTS-1					Pole Weight (lbs)
90 mph	100 mph	110 mph	120 mph	130 mph	
12.6	8.0	6.8	3.9	1.6	555

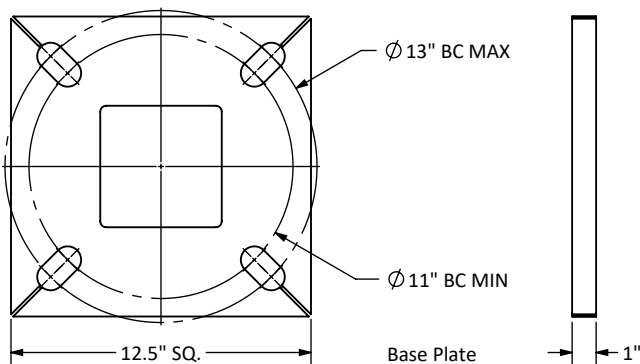

Disclaimer: All dimensions and specifications are subject to change without any notice. Energy Light, Inc. is not responsible for any claims arising from improper loading (what is attached to the light pole), improper use, incorrect foundation design and/or installation.